



Steam Cleaner

OWNER'S MANUAL

Model SC507

120V., 60 Hz, 1550 Watts

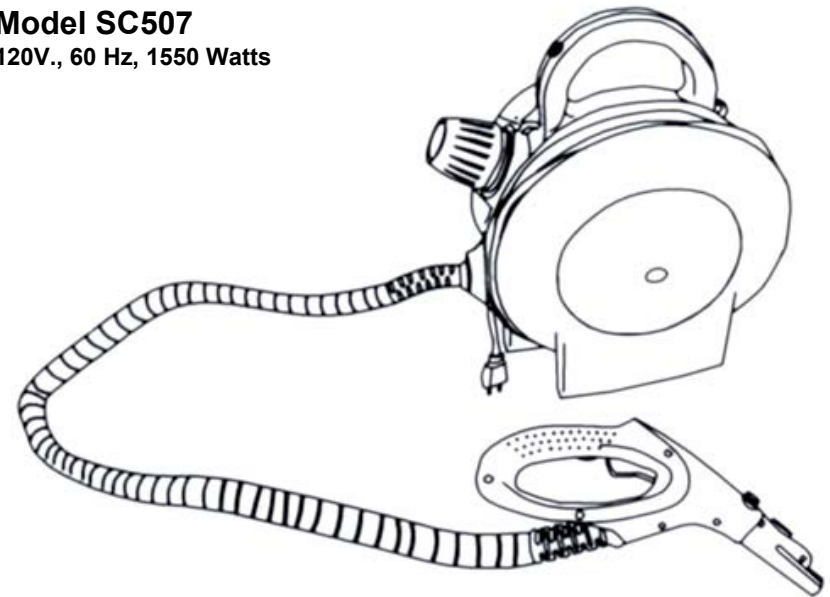

USA: EURO-PRO Operating LLC
94 Main Mill Street, Door 16
Plattsburgh, NY 12901

Canada: EURO-PRO Operating LLC
4400 Bois Franc
St. Laurent, QC H4S 1A7

Tel: 1 (800) 798-7398
www.sharkcompany.com

EURO-PRO 

Model
SC507



1 YEAR LIMITED WARRANTY

Your Steam Cleaner is warranted to be free from defects in material and workmanship for a period of one (1) year from the date of purchase when utilized for normal household use by the original purchaser only. The included Warranty Registration Card must be filled out and returned within 10 days of purchase. This is essential for your Warranty to be effective should any problem arise with this product.

Should any defect covered by the terms of the limited warranty be discovered within one year, **EURO-PRO Operating LLC** will repair or replace any defective part provided the unit is returned by the original purchaser, freight prepaid, to:

U.S. **EURO-PRO Operating LLC**, 94 Main Mill Street, Door 16, Plattsburgh, NY 12901
Canada: **EURO-PRO Operating LLC**, 4400 Bois Franc, St. Laurent, QC, H4S 1A7

Proof of purchase date and \$15.95 for handling and return packing/shipping charges must be included.*

The liability of under this warranty is limited solely to the cost of the replacement parts or the complete unit at our option. LABOUR CHARGES ARE NOT INCLUDED.

This warranty does not cover normal wear of parts and does not apply to any unit that has been tampered with or used for commercial purposes. This Limited Warranty does not cover damage caused by misuse, negligent handling, or damage due to faulty packaging or mishandling in transit (by any common carrier).

This warranty is extended to the original purchaser of the unit and excludes all other legal and/or conventional warranties. The responsibility of **EURO-PRO Operating LLC**, if any, is limited to the specific obligations expressly assumed by it under the terms of the limited warranty. In no event is **EURO-PRO Operating LLC** liable for incidental or consequential damages of any nature whatsoever. Some States/Provinces do not permit the exclusion or limitation of incidental or consequential damages, so the above may not apply to you.

This warranty gives you specific legal rights which vary from state to state or province to province.

*Important: Carefully pack item to avoid damage in shipping. Be sure to attach tag to item before packing with your name, complete address and phone number with note giving purchase information, model number and what you believe is the problem with item. We recommend you insure the package (as damage in shipping is not covered by your warranty). Mark the outside of your package "ATTENTION CUSTOMER SERVICE". **We are constantly striving to improve our products, therefore the specifications contained herein are subject to change without notice.**



OWNERSHIP REGISTRATION CARD FOR CANADIAN CONSUMERS ONLY

Please complete and return within ten (10) days of purchase. The registration will enable us to contact you in the event a product defect is discovered. By returning this card you acknowledge to have read and understood the instructions for use, and warnings set forth in the accompanying instructions.

RETURN TO: **EURO-PRO Operating LLC**, 4400 Bois Franc, St. Laurent, QC H4S 1A7

PURCHASER:

ADDRESS:

CITY: PROV.....

DATE OF PURCHASE: MODEL: **SC507**

TIPS ON HOW TO USE YOUR SYSTEM

ALWAYS FINISH CLEANING BY WIPING DOWN THE CLEANED SURFACE WITH A TOWEL

Hints

The steam cleaner has many uses that have not been mentioned. This was meant only to give you a general idea of what can be achieved with the unit. However, the ways in which to use the attachments and brushes are in most cases universal. It is **most** helpful to always have a terry cloth towel or paper towel ready to use for removal of moisture and residue. 100% white cotton towels work best.

You can clean the brushes with your steam cleaner. When cleaning the bristle brushes, use a pair of pliers to hold and blow dirt as above or place in the basket of your dishwasher.

Note: Wipe with a towel immediately before the cleaned area dries. When cleaning the oven, use the bristle brush to clean around the elements and drip trays. Use the bristle brush for cracks, crevices, and hard to reach areas.

Refrigerator - Use the concentrator to blow away dirt in the ice machine and on door seals. The vapor will not dry out or crack the seals as chemicals often do. Can openers and other kitchen equipment can be easily cleaned with the bristle brush to get into all the nooks and crannies. Mold stains around door gaskets can be removed with the bristle brush.

To clean **microwaves** or **other small appliances** use the nylon bristle brush for small areas.

Note: When cleaning small electrical appliances always unplug them from outlet before cleaning. Do not direct steam into any openings of the appliances.

To clean **counter tops**, use the bristle brush first in order to loosen the debris, then wipe with a terry cloth towel to finish.

ORDERING SUPPLIES

If you need to order supplies such as steam pocket towels, etc. please call the customer service number at 1 (800) 798-7398.

IMPORTANT SAFETY INSTRUCTIONS

When using your **Steam Cleaner**, basic safety precautions should always be observed, including the following:

1. Read all instructions before using your steam cleaner.
2. Use the system only for its intended use.
3. To protect against a risk of electric shock, do not immerse any part of the system in water or other liquids.
4. Never yank cord to disconnect from outlet; instead, grasp plug and pull to disconnect.
5. **Do not** allow cord to touch hot surfaces. Let the system cool completely before putting away or opening water tank (removing the safety cap). Wrap cord loosely around system when storing.
6. Always disconnect system from electrical outlet when filling with water or emptying and when not in use. Always turn the safety cap slowly when opening the water tank. This will allow any remaining steam to escape gradually.
7. **Do not** operate the system with a damaged cord or plug, or if the appliance or any other part of the system has been dropped or damaged. To avoid the risk of electric shock, do not disassemble or attempt to repair the steam cleaner. Return the system to **EURO-PRO Operating LLC** (see warranty) for examination and repair. Incorrect re-assembly or repair can cause a risk of electrical shock or injury to persons when the steam cleaner is used.
8. Close supervision is necessary for any appliance being used by or near children. **Do not** leave the system unattended while connected to electrical outlet or when hot.
9. Burns can occur from touching hot metal parts, hot water or steam. Use caution when draining unit after use as there may be hot water in the unit. Never direct steam at any person. The steam is very hot and can cause burns.
10. **Do not** operate in the presence of explosive and/or flammable fumes.
11. This appliance is intended only for household use. Follow all user instructions in this manual.
12. Never use any chemicals or substance other than tap water in the machine. Use of chemicals may damage the machine. Use of chemicals will automatically void your warranty.

To reduce the risk of fire, electric shock, or injury:

- **Do not** leave the steam cleaner plugged in when unattended. Unplug the electrical cord when not in use and before servicing or refilling water tank.
- **Do not** allow to be used as a toy. Close attention is necessary when used by or near children, pets or plants.
- Use only as described in this manual. Use only manufacturer's recommended accessories.
- **Do not** pull cord, use cord as a handle, close a door on cord, or pull cord around sharp edges or corners. Keep cord away from heated surfaces.
- **Do not** use extension cords or outlets with inadequate current carrying capacity.
- **Do** turn off all controls as applicable before unplugging from electrical outlet.
- **Do not** unplug by pulling on cord. To unplug, grasp the plug, not the cord.
- **Do not** handle plug or steam cleaner with wet hands or operate without shoes.
- **Do not** put any objects into openings. Do not use with any opening blocked.
- **ALWAYS STORE YOUR APPLIANCE INDOORS** in a cool, dry area.
- **Do** keep your work area well lit.
- **Do Not turn the appliance over or on its side. Never direct steam towards people, animals or plants.**
- **Do not** immerse the steam cleaner into water or other liquids. Always unplug the power cord from the electrical socket when filling the steam cleaner.
- **Do NOT add cleaning solutions, scented perfumes, oils or any other chemicals to the water used in this appliance as this may damage the unit or make it unsafe for use.** Use tap water or distilled/purified water if the tap water in your area is very hard.

SAVE THESE INSTRUCTIONS

For Household Use Only

ADDITIONAL IMPORTANT SAFEGUARDS

1. To avoid circuit overload, **do not** operate another appliance on the same socket (circuit) as the steam cleaner.
2. If an extension cord is absolutely necessary, an extension cord rated a minimum of 15 ampere, 14 gage cord should be used. Cords rated for less amperage may overheat. Care should be taken to arrange cord so that it cannot be pulled or tripped over.
3. **Do not** leave unattended when the system is connected to a power supply/electrical outlet.



WARNING: This appliance is equipped with a grounded, type 3-wire cord (3-prong plug). This plug will only fit into an electrical outlet made for a 3-prong plug. This is a safety feature. If the plug should fail to fit the outlet, contact an electrician to replace the outlet. Do not attempt to defeat the safety purpose of the grounding pin, part of the 3-prong plug.



CAUTION: Always drain condensed water from hose before use or if unit has been left idle for a period of time. To drain hose, direct nozzle into an appropriate container or sink and depress hand grip steam trigger. Once hose has been drained, normal use may be resumed. Never direct nozzle towards people, animals or plants.



WARNING: Your Steam Cleaner is designed to clean hard surfaces and upholstery that will withstand high heat. Do not use on soft plastics and cold glass. On surfaces that have been treated with wax or some no wax floors, the sheen may be removed by the heat and steam action. Do not use on unsealed wood. This could cause the wood grain to rise. It is therefore recommended to test an isolated area of the surface to be cleaned before proceeding.

IMPORTANT:

Do **NOT** add cleaning solutions, scented perfumes, oils or any other chemicals to the water used in this appliance. Use regular water or distilled/purified water if the tap water in your area is very hard.



WARNING: Danger of Scalding. Please use caution when using the steam cleaner. The steam emitted from this opening is very hot.

SAVE THESE INSTRUCTIONS FOR HOUSEHOLD USE ONLY

TIPS ON HOW TO USE YOUR SYSTEM

Fiberglass or Stainless Steel Surfaces

Use the bristle brush. Slowly move the brush over the surface to be cleaned. The vapor will emulsify the dirt and grease on the surface. Follow behind with a terry cloth towel over the brush to remove excess moisture and residue. **Tip:** An old idea for polishing stainless steel is to wipe it down with seltzer soda water after it is cleaned.

Bathroom Areas

To clean the bathtub or shower area, use the bristle brush for grout, shower door tracks, hard to get areas and heavily soiled areas. The dual edge window/tile squeegee will be the most efficient way to clean the rest of the area. Allow plenty of time for the heat to penetrate the surface. This is especially helpful in the shower area if there is tile or grout. Wipe with towel.

Removal of soap scum on tile, grout, and shower doors is also easier with the steam cleaner.

To clean sanitary fixtures, use the concentrator with or without bristle brush. Use a terry cloth towel or paper towel to wipe up excess moisture and residue. To clean the sink and faucets, use bristle brush then finish by wiping with a towel.

Soap Scum

Soap scum dissolves almost immediately under a combination of heat and moisture. Rinse the surface with a small amount of water afterwards or go back over it once more with a clean terry cloth towel.

Note: Soap scum sometimes will develop a hard surface from waterborne minerals. If this is the case, use the bristle brush to break up this surface - or spray or wipe first with lemon, vinegar or seltzer soda water to soften the minerals. Moving too slowly can dry out the soap scum and cause it to granulate on the surface. The surface will have a gritty feel. If this happens, apply vapor to the surface with the bristle brush again and re-clean.

Garden Furniture

Use any of the brushes depending on the surface area. Work quickly when cleaning resin outdoor furniture. Finish by wiping with a towel.

Blinds

Use the nylon bristle brush to clean blinds. Move the brush over the surface, allowing enough time for the vapor to penetrate. Work quickly on PVC blinds. Test for color fastness on fabric blinds before using. Finish by wiping with a towel.

Automotive

For detailing the wheels, use the concentrator and the bristle brush. Exterior windows are cleaned best by applying the vapor with the concentrator and following with a paper towel. To clean bicycles, use the bristle brush. To clean equipment, use the bristle brush, depending on the surface area. Finish by wiping down with a towel.

Artificial Plants

Use the concentrator without a brush attached to blow off the dust and dirt.

Clothing

A vapor cleaning system is excellent for removing wrinkles from fabrics. Simply "vaporize" the surface from a distance (12"-18") The dry vapor removes wrinkles without leaving the fabric wet like ordinary fabric steamers do.

Nicotine and Tar

Nicotine and tar dissolves at high temperatures and becomes a light yellow oil that has the consistency of sewing machine oil. When the nicotine/tar film is touched by steam pocket, it immediately dissolves and flows into the steam pocket towel. You can remove it from flat surfaces as fast as you can move the steam pocket over the surface.

Removing Wax, Tar, Etc.

Many stains are only stuck on the surface of materials and can be easily and quickly removed by "blowing" excess material away from the surface from the side. This is accomplished by using the concentrator. Hold the terry cloth towel to the side to catch the loose residue as it is blown by the concentrator. **Note:** Always vacuum any loose residue off the surface before you apply vapor to it.

TIPS ON HOW TO USE YOUR SYSTEM

Wood, Vinyl and Marble Floors

Use the Steam Pocket™ to clean wood, vinyl and marble floors. Move the Steam Pocket™ across the floor as if you are mopping. When one side of the towel is soiled, turn the Steam Pocket™ frame and use the other side. One of the great advantages of using our Steam Pocket™ is that your floor will dry faster than if you used a mop or other floor cleaning device. It is normal that some moisture may be left behind depending on how quickly you move the Steam Pocket™ across the floor and the relative heat and humidity of the room. Be sure to move quickly and steadily over wood, linoleum and vinyl flooring to avoid damaging the surface and removing wax.

To Clean Waxed Floors: Use the Steam Pocket™ with quick strokes. This will cause the dirt to be removed but not the wax.

Vinyl Floors: Do not allow heat to build up in any kind of vinyl since it can soften it enough to affect its texture. Work fast on vinyl.

Tile Floors: Use the concentrator with the bristle brush. Have the Steam Pocket™ ready as well. Clean the grout between the tiles with the bristle brush. Remove the concentrator and bristle brush and attach the hose and Steam Pocket™. Move the Steam Pocket™ across the floor to clean the tile and remove excess moisture and residue.

Spot Cleaning (Carpets)

Use the concentrator with or without the bristle brush. Move slowly over the soiled area, allowing the steam to penetrate. Agitate with bristle brush or clean towel. Dab the spot with the towel (do not rub). Repeat as necessary to remove stain. Vacuum only after the carpet has completely dried.

Always test color fastness of carpet in an inconspicuous area before cleaning.

If your steam cleaner fails to remove stubborn stains a commercially available carpet shampoo may be required. **Do NOT** add cleaning solutions, scented perfumes, oils or any other chemicals to the water used in this appliance as this may damage the unit or make it unsafe for use.

CAUTION: Always determine the color-fastness of any fabric—especially with reds or blues—by taking a clean, moist, warm towel and gently rubbing a small area as far down on the back or other out of the way place on the furniture as possible. If color comes off on the towel, you may need to have the piece dry cleaned.

Window, Glass Surfaces and Mirrors

Use the window squeegee. Work with the vapor jet on using the top to bottom movements. Use the squeegee with the vapor off to clear the water from the glass. To do this without leaving streaks, use lateral movements from the top to the bottom of the surface.

CAUTION: When cleaning windows, always avoid any sudden changes in temperature to prevent glass breakage or cracks.

GETTING TO KNOW YOUR STEAM CLEANER

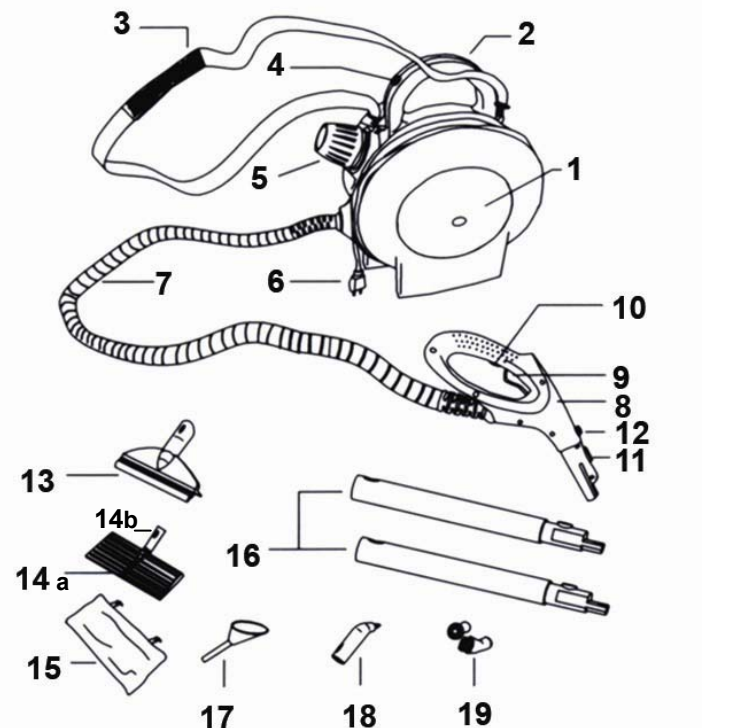

- | | |
|---|---------------------------------|
| 1. Main Unit | 9. Steam Trigger |
| 2. Handle | 10. Steam Trigger Lock |
| 3. Shoulder Strap | 11. Locking Button |
| 4. Power "On" (Red) / Steam Ready (Green) Light | 12. Variable Steam Control |
| 5. Safety Cap | 13. Window Squeegee |
| 6. Power Cord | 14a. Steam Pocket Frame |
| 7. Flexible Hose | 14b. Steam Pocket Angle Adapter |
| 8. Hand Grip | 15. Steam Pocket Towel |
| | 16. Extension Tubes (x2) |
| | 17. Funnel |
| | 18. Concentrator |
| | 19. Nylon Bristle Brushes (x2) |

Technical Specifications

Voltage:	120V., 60Hz.
Power:	1550 Watts
Water Capacity:	27 US fl. oz. (800 ml.)
Steam Generator:	Stainless Steel

* Illustrations may differ from actual product.

FEATURES OF STEAM CLEANER

1. Multipurpose Steam Cleaner:

Bathrooms, kitchens, living areas, pet areas and appliances.
Automotive, patio and windows.

4. Heavy-duty crush-resistant hose.

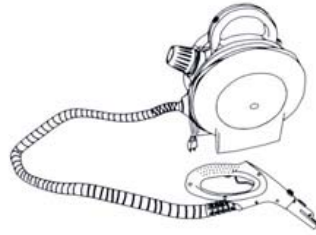

2. Lightweight & Portable



5. Versatile, quick-change accessories

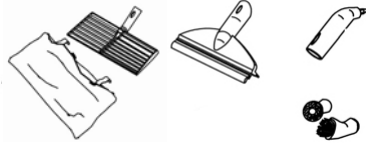

3. Stainless Steel Boiler:

Non-corroding, stainless steel boiler. Welded construction.

TIPS ON HOW TO USE YOUR SYSTEM

Care and Maintenance

If you consistently use demineralized or distilled water, cleaning the tank is unnecessary.

Rinsing Out the Steam Cleaner

Normally, a periodic rinse of your steam cleaner will free it from deposits. This is recommended every 10-15 tankfills, to free up any scale deposits from the tank. Fill the boiler with 20 oz. of water and shake the cleaner vigorously. Tilt the cleaner upside down to empty the boiler of water and any scale deposits.

Descaling Your Steam Cleaner

If the tap water in your area contains a high level of calcium deposits and you have been using tap water to do your steam cleaning, you should descale your unit after 10-15 tankfills.

To Descal the Steam Cleaner

Step 1: Unplug the steam cleaner from the power source before you descale the boiler. Allow to cool for 15 minutes.

Step 2: Fill the boiler with 1 part vinegar and 5 parts water and leave overnight or for a period of approximately 8 hours. Do not screw the safety/filler cap onto the steam cleaner while you are descaling the boiler. **Do not use the steam cleaner while descaling solution is inside the boiler.**

Step 3: After the period of soaking, turn the steam cleaner upside down to empty solution from the boiler. Due to the fact that a small amount of solution will be left in the boiler, it is necessary to rinse the boiler out with clean water 2 or 3 times. Your steam cleaner is now ready for use.

Note: When storing your unit, always drain any residual water in the boiler and do not tighten the safety filler cap onto the unit. Always leave the safety filler cap loose on the unit when not in use.

Water

- Use tap water for all your cleaning needs.
- However, if you live in an area with hard water, use de-mineralized / distilled water when steaming light colored fabrics to eliminate the possibility of hard water stains.

IMPORTANT: Do **NOT** add cleaning solutions, scented perfumes, oils or any other chemicals to the water used in this appliance. **Use tap water or distilled/purified water if the tap water in your area is very hard.**

Efficient Work

- For vertical surfaces, wipe with a towel from the top down, in this way the dirty water will not soil surfaces already cleaned.
- Avoid changing brushes back and forth while cleaning.
- Start with the smallest brush to clean tight spots and corners first.
- Use a towel to wipe dirt as soon as possible, otherwise it will dry and re-adhere to the surface.

OPERATING INSTRUCTIONS

Attaching the Shoulder Strap

Using the detachable shoulder strap allows for greater freedom of movement when both hands are needed for various cleaning tasks. To attach the shoulder strap to the steam cleaner, simply snap the shoulder strap hooks onto the connecting rings on the unit body. See Fig. 11, 12 & 13.

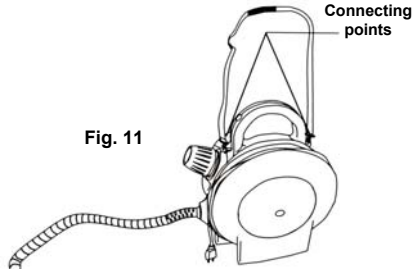

Fig. 11



Fig. 13

IMPORTANT: When using the steam cleaner with the shoulder strap, avoid rocking or tilting the unit excessively as this may cause water to enter the hose and be discharged along with the steam.

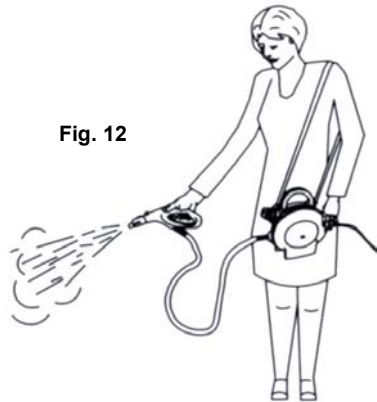

Fig. 12

OPERATING INSTRUCTIONS

Components

Power "On" Light (red): This light will illuminate when the unit is plugged into the 120V. wall outlet. It will then turn "green" when the steam is ready.

⚠ CAUTION: Read the instructions for "Filling the Water Tank" before opening the Safety Cap.

⚠ CAUTION: Always unplug before filling. **ALLOW UNIT TO COOL FOR FIFTEEN (15) MINUTES BEFORE REFILLING.**

IMPORTANT: Do **NOT** add cleaning solutions, scented perfumes, oils or any other chemicals to the boiler in this appliance. **Use tap water or distilled/purified water if the tap water in your area is very hard.**

Filling or Refilling Your Steam Cleaner With Water

IMPORTANT: Always insure that the unit is "UNPLUGGED" from the wall receptacle prior to initial filling or re-filling the water tank and has been allowed to cool for 15 minutes. **Never attempt to fill this unit under a water tap, always use the filling funnel provided.**

- Step 1: Before refilling the steam cleaner, make sure that the unit is **NOT** plugged in and has been allowed to cool for fifteen (15) minutes.
- Step 2: Plug the power cord in to an electrical outlet and press the steam trigger on the hand grip to vent any residual steam that is in the boiler.
- Step 3: Remove the power cord from the electrical outlet.
- Step 4: Place the unit on a flat, stable surface. Slowly turn the safety filler cap counter clockwise until it is removed.
- Step 5: Insert the funnel into the tank opening and add 27 US fl. oz. (800 ml) of water. (Fig. 2) Place the funnel in the tank opening as illustrated in Fig. 1. The funnel has been specially designed to show when the water tank is full. When water starts to come out of the vent hole of the funnel, the tank is full. Remove the funnel slowly and let the remaining water in it to go inside the water tank. **Do Not Overfill.** Replace the Safety Cap.

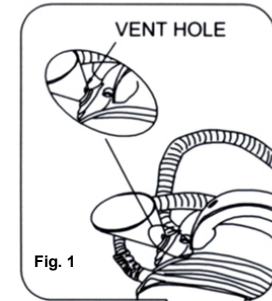

Fig. 1

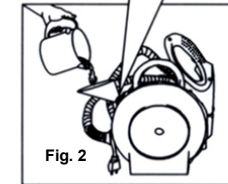

Fig. 2

⚠ WARNING: Allow unit to cool for 15 minutes before refilling. When refilling the steam cleaner while the boiler is still hot, there is a risk that water will squirt back during filling and cause scalding. Extreme care should be taken when refilling the unit. Use caution when opening the Safety Cap as it may become hot during use and escaping steam can cause scalding.

- Step 6: Connect desired attachments onto the end of the hand grip.
- Step 7: Plug the unit into a standard (120 volt, grounded) wall receptacle. Allow approximately 8-10 minutes for vapor to reach its working temperature and pressure. When the unit is ready for use, the red light will change to green. Always point nozzle outlet in a safe direction. At the start, some water will come out from the nozzle. This is normal.

NOTE: When the steam cleaner has run out of water, steam output will cease.

OPERATING INSTRUCTIONS

Using the Trigger Lock

The steam cleaner has a steam trigger lock. The steam trigger will lock when you have pushed it all the way in. (Fig. 3) To unlock the steam trigger, just press it in the other direction. If you want to have continuous steam, depress the steam trigger and then push in the steam trigger lock.

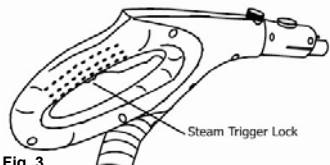

WARNING: This appliance is under pressure. After every use, unplug the unit and press the steam trigger button until all pressure has been released before removing safety cap. Allow unit to cool for fifteen (15) minutes before refilling.

Using the Variable Steam Feature

Your steam cleaner has a variable steam feature that allows you to adjust the steam flow to the job that you are doing. The variable steam control is located on the handgrip. To increase the steam flow, turn the knob counter clockwise and to decrease, turn it clockwise. (Fig. 4)

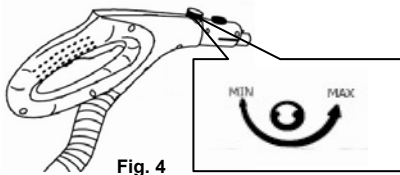

Using Your Steam Cleaner with Steam Pocket

Step 1: Connect one of the extension tubes to the hand grip on the flexible steam hose. To attach the extension tubes one onto the other or onto the hand grip, press the locking button ensuring that it fits into the hole. (Fig. 5, Fig. 6) To disconnect, repeat the operation by pressing the locking button and pulling the two sections apart.

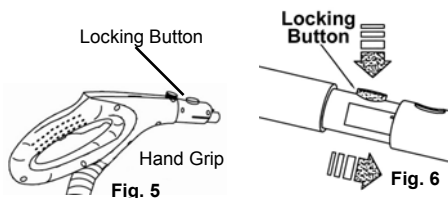

NOTE: Fit the steam pocket frame with the angle adapter onto the extension tube.

Step 2. If the angle adapter is not attached to the steam pocket frame, attach as follows: Hold the steam pocket frame in one hand and the angle adapter in the other. Insert the angle adapter stem into the opening of the steam pocket frame as shown in Fig. 7. Note that the flat on the nozzle must face toward the side of the frame with the brass pin. Once inserted, rotate it 90°

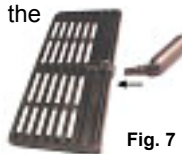

Step 3. Insert the electrical power cord into the outlet. Heating time is approximately 8-10 minutes with cold water. Filling the steam generator with hot water will shorten the heat up time.

Attaching the Steam Pocket Towel to the Frame

WARNING: Always insure the unit is "UNPLUGGED" from the wall receptacle prior to attaching or removing accessories.

1. Slide the steam pocket towel over the steam pocket frame. (Fig. 8)

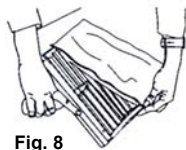

2. Bring the towel all the way to the top of the steam pocket frame. (Fig. 9)

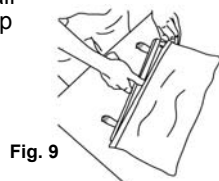

OPERATING INSTRUCTIONS

3. Bring the velcro strips that are on the back side of the steam pocket towel over the steam pocket frame and attach to the inside of the front side of the steam pocket towel. (Fig. 10)

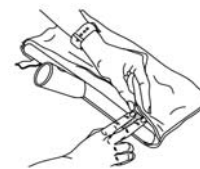

NOTE: When replacing the steam pocket towel, make sure that the steam pocket frame has been allowed to cool before removing or attaching a new steam pocket towel.

Care & Maintenance of the Steam Pocket Towel

Due to the unique cleaning ability of this cloth, proper care of your microfiber towel is required to ensure long life and continued cleaning ability.

- The first thing you should do when you get a new microfiber towel is to wash and dry it. During the manufacturing process the fabric has a tendency to become flat as it picks up contaminants from the air and machinery. There will also be a number of loose threads that, while they cause no harm, can be annoying the first time you use the towel.
- To clean the towel, simply wash it in your washing machine using the warm water setting.
- Always wash your towels separately from other fabrics. They have a tendency to pick up lint and other particles from other fabrics and the next time you use your towel, this lint will transfer to the surface being cleaned.
- ONLY USE LIQUID DETERGENTS**, never use dry detergents as many times the granules do not fully dissolve and become trapped in the towel. This can scratch the surface that you are cleaning.
- NEVER USE BLEACH OR FABRIC SOFTENERS!** Bleach will damage the microfiber fabric and fabric softeners deposit a coating on the microfiber fabric that will not allow the cloth to clean efficiently.

- Air dry the towel. Do not put in a clothes dryer as high heat will cause the towel to shrink and the microfibers to break down.
- If you wash your towel on a regular basis and don't let them get too dirty, they will last much longer. As with any fabric, dirt particles, grease and other contaminants can cause the fibers to break down, therefore regular cleaning will help preserve your microfiber towels.
- As you use the microfiber towel, you will notice that sometimes a thread will loosen or pull out. This is normal and you should **NEVER PULL AT THE LOOSE THREAD!** Pulling the thread can cause the weave to come undone. Instead, simply trim the thread with a pair of sharp scissors.

Attaching the Accessories to the Flexible Steam Hose

Allow the unit to cool for 15 minutes before changing accessories.

Window Squeegee

This attachment is very useful for cleaning large windows, plastic material, ceramic, tiled or marble surfaces.

IMPORTANT: When cleaning windows, always avoid any sudden changes in temperature to prevent glass breakage or cracks.

To use: Connect the tile squeegee to the hand grip or use with extension tube for hard to reach surfaces.

Apply steam abundantly, rub with the soft spongy edge, then remove excess water and dirt with the glass wiping edge.



Concentrator

Attach the concentrator to the handgrip or to the extension tubes.

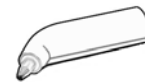

Nylon Bristle Brush (x2)

It is best for cleaning grout in-between the ceramic and marble tiles.

To use: Attach the nylon bristle brush on to the end of the concentrator, which then may be used directly on the hand grip or with extension tubes.

